



**A L B I O L**

2021



**ALBIOL 2021**



**Concep Collection** / Chaise Long Whit Backrest+Side  
**Views** / mirror  
**Aitana** / low table



**Concep collection** / chaise long whit backrest + side  
**Concep collection** / pouf  
**Aitana** / low table  
**Concep collection** / magazine rack

**Concep Collection** / chaise long whit backrest + side  
**Octo** / low table  
**Silbox** / folding door  
**Concep collection** / magazine rack





Concep Collection / chaise long whit backrest + side vis-à-vis  
Concep Collection / chaise longue  
Concep Collection / bench  
Concep Collection / bench whit backrest  
Ibiza / low table



**Concep Collection** / chaise long whit backrest + side  
**Concep Collection** / magazine rack complement  
**Zara** / low table





Concep Collection / chaise longue vis-à-vis  
Concep Collection / chaise longue  
Jub / table  
Aitana / low table  
Shelves

Concep Collection / bed  
Silbox / with drawer





**Concep Collection** / bed  
**Silbox** / with drawer and legs  
**Jud** / table

Concep Collection / bed  
Concep Collection / pouf  
Octo / low table  
Silbox / with drawer  
Silbox / swing door  
Lunaa belt / pendulum mirror + led



ALBIOL 2021

Concep Collection / bed  
Silbox / with drawer





Views / mirror  
Concep Collection / bed  
Silbox / with drawer

Views / mirror





Views / mirror  
Concep Collection / bench  
Silbox / with folding door





ALBIOL 2021

Views / mirror  
Octo / low table





**Lunaa belt** / pendulum mirror + led  
**Silbox** / with drawer



Lunaa belt / triangle mirror + led



Lunaa belt / mirror





ALBIOL 2021

Ade / flower pot  
Lunaa belt / mirror



**Lunaa** / mirror  
**Octo** / low tables  
**Uve** / magazine rack





Lunaa / mirror





Trian / mirror



Ibiza / low table  
Concep Collection / chaise longue vis-vis  
Concep Collection / bench whit backrest



Ibiza / low table



Silbox / with drawer





Silbox / folding door  
Silbox / folding door  
Jud / table



**Silbox** / with drawer and legs  
**Concep Collectio** / bed



**Silbox** / with drawer  
**Lunaa Belt** / pendulum mirror + led





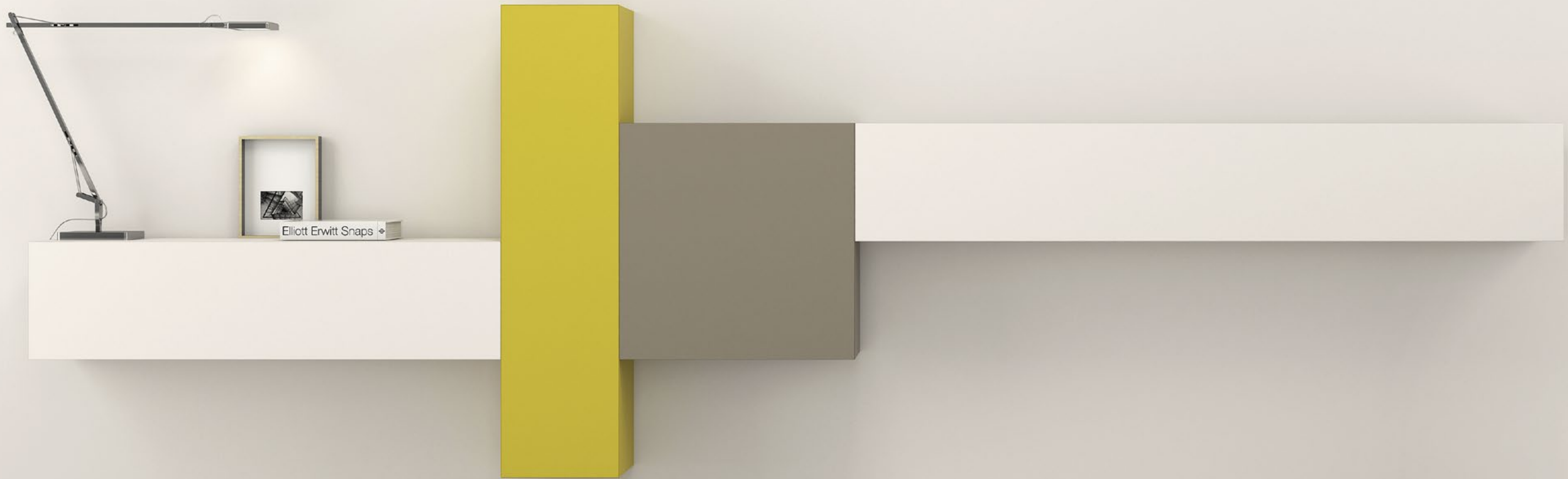

Silbox / with drawer

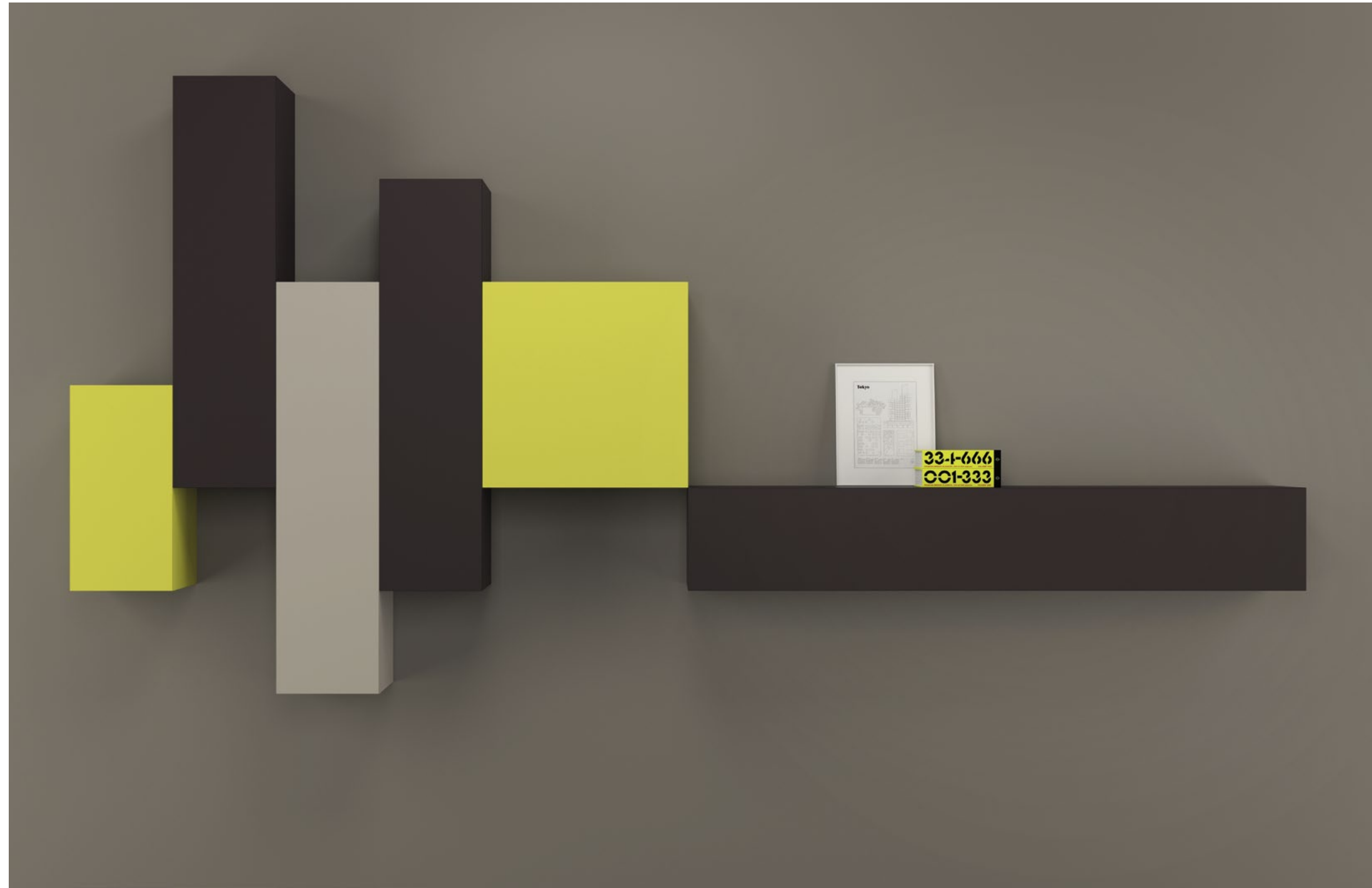



**Silbox** / folding door  
**Silbox** / with drawer



ALBIOL 2021

Silbox / with door  
Jud / table



Jud / table















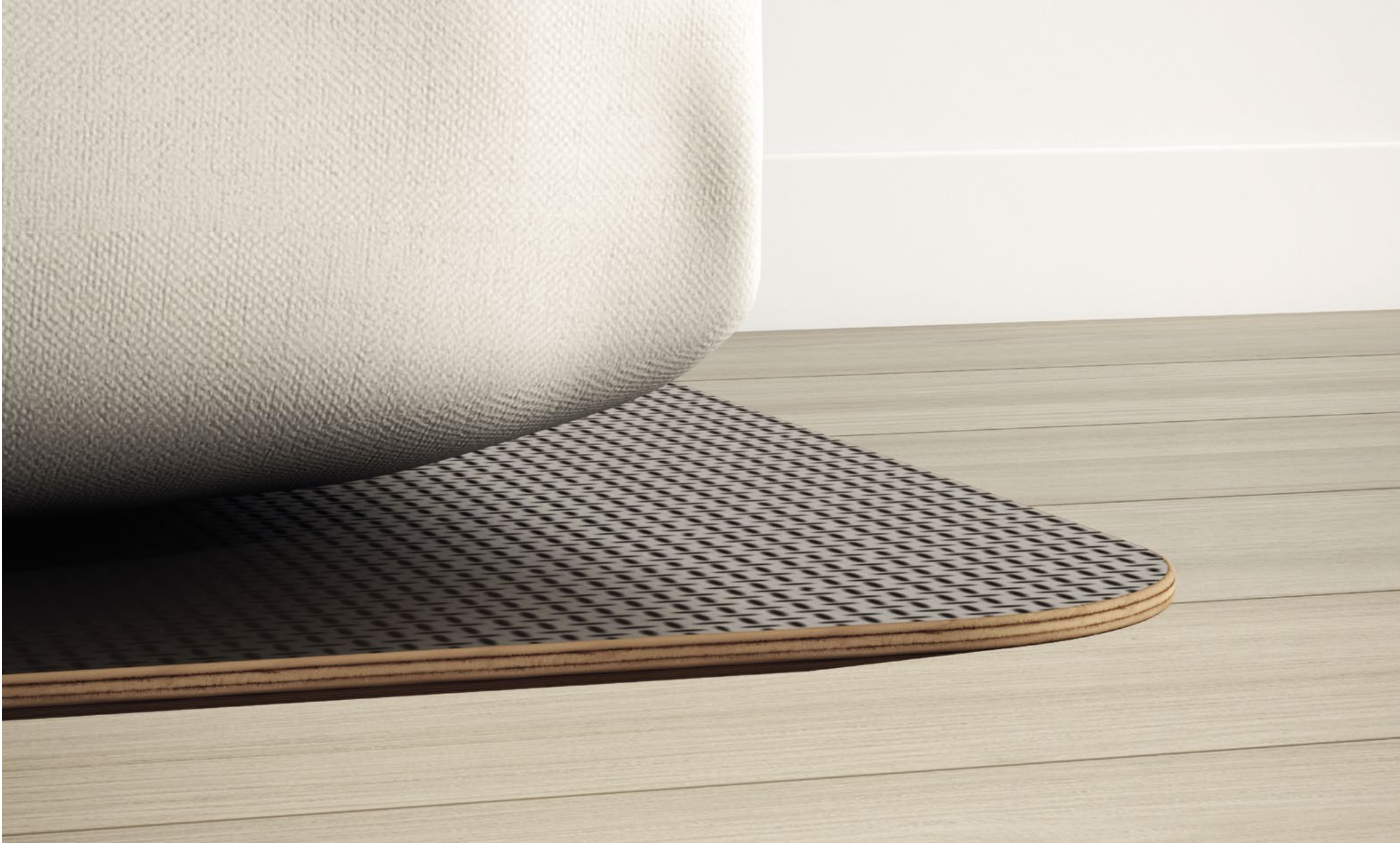







Aitana / table  
Marco / upholstered acoustic panel









ALBIOL 2021

Zara / table  
Marco / upholstered panel  
Marco / lacquered panel





Octo low table



ALBIOL 2021











Marco / upholstered panel  
Shelves / frame headboard upholstered  
Marco / headboard smooth upholstered  
Marco / lacquered panel  
Shelves



Jud / bed base  
Marco / headboard upholstered bands  
Silbox  
Shelves / marco 360°



smooth upholstered



upholstered bands



checkered upholstered





**Marco** / headboard smooth upholstered  
**Marco** / upholstered panel  
**Aitana** / table  
**Silbox**  
**Shelves**



ALBIOL 2021

Marco / upholstered panel  
Marco / 360°  
Shelves





ALBIOL 2021





Marco / mirror  
Jud / table  
Marco / upholstered acoustic panel





Marco / mirror



Shelves  
Marco / mirror  
Marco / 360°

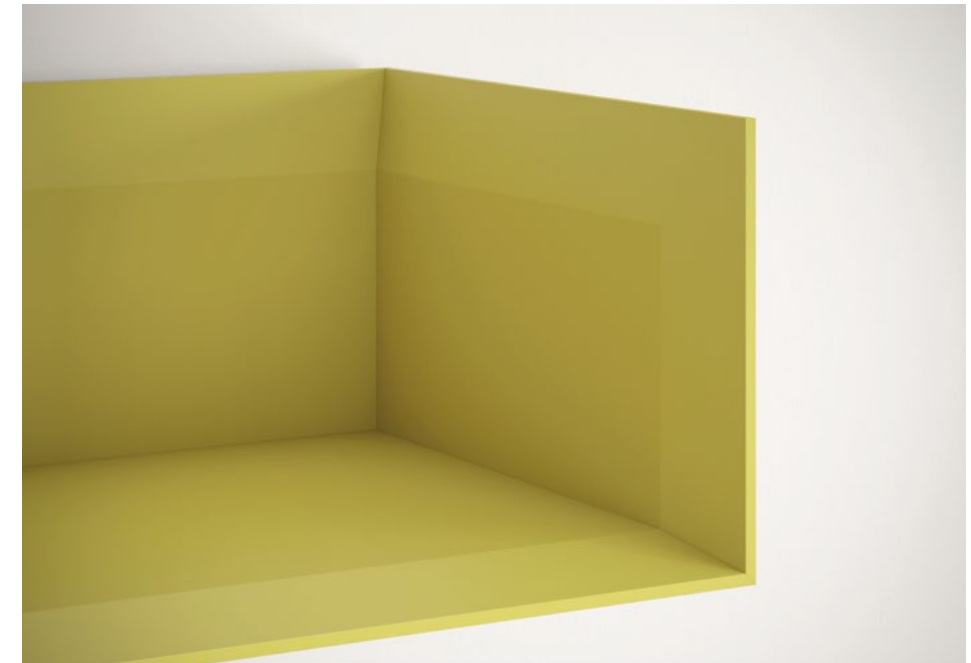
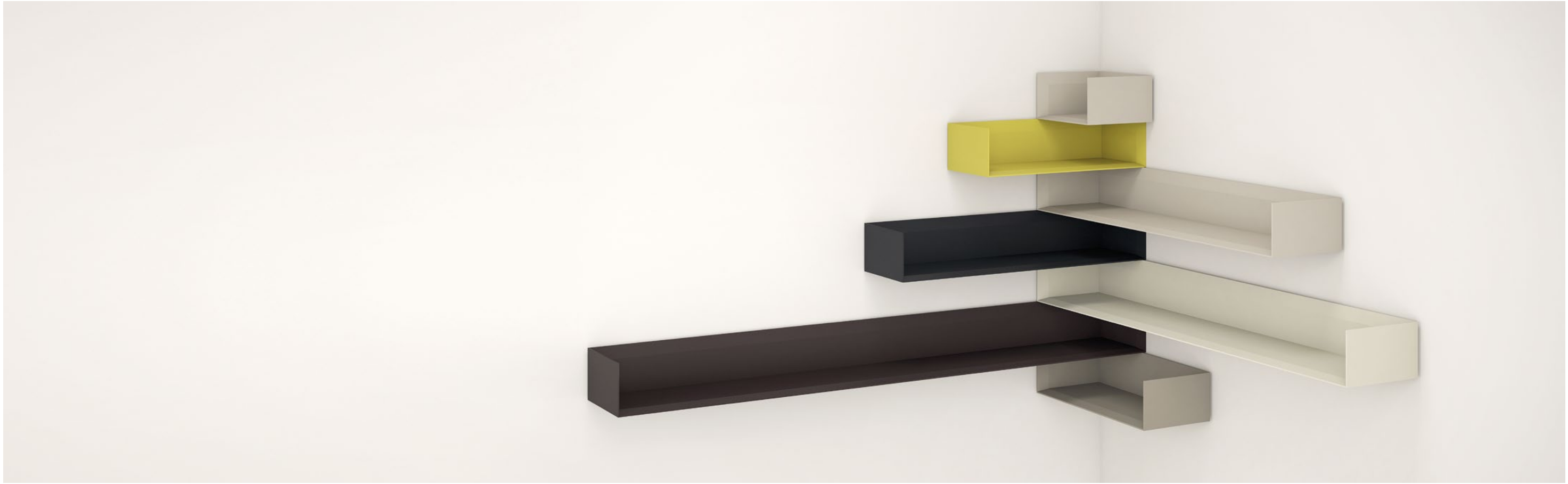





Shelves



Marco / mirror  
Shelves



Silbox  
Shelves



Marco / shelves









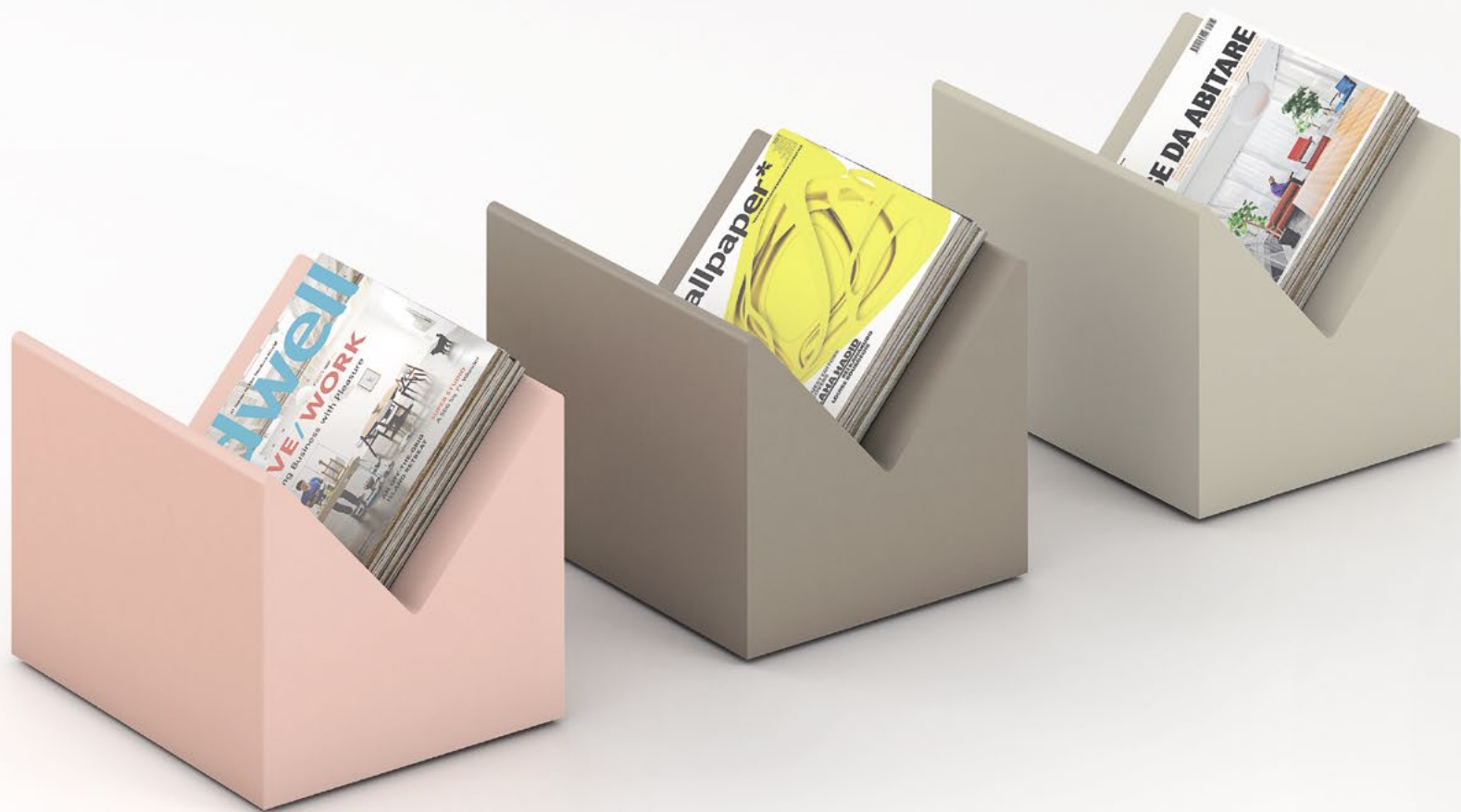





ALBIOL 2021







Ade / flower pot  
Marco / mirror

Ade flower pot



ALBIOL 2021







## CONCEP collection.

---

---

Esta amplia colección de piezas tapizadas de líneas rectas y robustas, ofrece multiples opciones en cuanto a formas, medidas y acabados. Desde un simple pouff, hasta una chaise longue te permiten integrar las piezas que mejor se adapten en una recepción, habitación o salón. También se incluye en esta colección la versión cama, con medidas que se adaptan a los estándares de los fabricantes de colchones y con un sistema de unión que facilita el transporte y montaje.

The Concep collection is one of the new releases of this year. This wide collection of upholstered pieces with straight and robust lines, offers many options in terms of shapes, sizes and finishes. From a simple “pouf” to a “chaise longue”, they allow you to integrate the pieces that best suit a reception, room or living room. There is also a bed version included to the collection. Its measures are adapted to the standards of mattress manufacturers and its joining system facilitates transport and assembly.

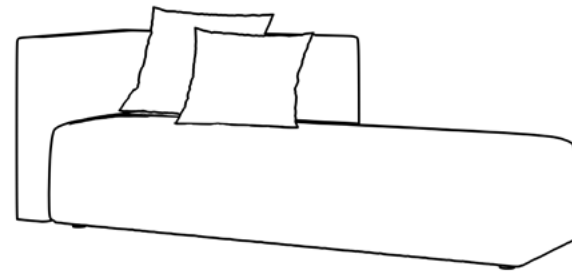

**Medidas/Sizes cm**  
(Ancho x Alto x Fondo) (Width x Height x Depth)

110 x 225 x 25

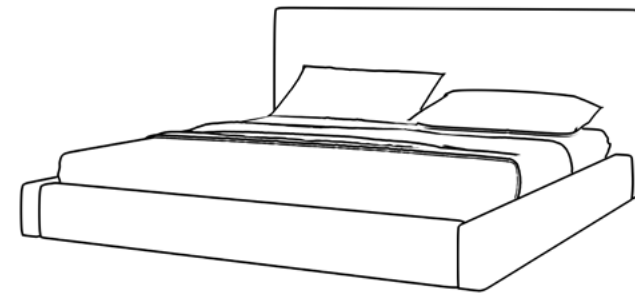

**Medidas/Sizes cm**  
(Ancho x Alto x Fondo) (Width x Height x Depth)

00,0 x 00,0 x 00,0

---

---

## COMPLEMENTO CONCEP collection.

El complemento del chaise long es un revistero con los cantos biselados, siguiendo así las líneas minimalistas presentes en todas nuestras colecciones. Se fabrica en DM lacado en cualquiera de los 20 colores de la colección

The complement to the chaise long is a magazine rack with beveled edges, following the minimalist lines present in all our collections. It is manufactured in lacquered MDF in any of the 20 colors in the collection.

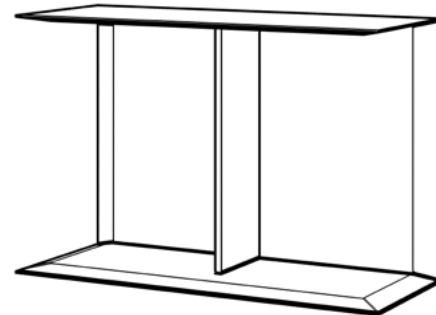

**Medidas/Sizes cm**  
(Ancho x Alto x Fondo) (Width x Height x Depth)

11 x 22,5 x 25

---

---

## IBIZA low table.

Esta colección nace tras la premisa de hacer una mesa de centro para un proyecto de interiorismo llevado a cabo por el estudio Farre&Costa en un apartamento de las terrazas de Botafoch en Ibiza. Se produce en madera de roble macizo, con una sección especial y unida en todos sus encuentros a inglete. Este detalle hace que sea una mesa única en el mercado. Para la tapa puedes elegir un porcelánico de living ceramic o cristal transparente óptico. El acabado de la estructura en madera natural o lacado en uno de nuestros colores a poro abierto, mostrando así el dibujo de la propia madera. Disponible en dos tamaños, 123x123x38 y 63x63x38

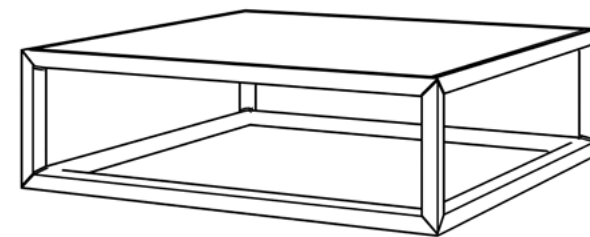

**Medidas/Sizes cm**  
(Ancho x Alto x Fondo) (Width x Height x Depth)

123 x 123 x 38  
63 x 63 x 38

This collection was born after the premise of making a coffee table for an interior design project carried out by the Farre & Costa studio in an apartment in the Terrazas de Botafoch in Ibiza. It is produced in solid oak wood, with a special section and mitered in all its joints. This detail makes it a unique table in the market. For the top you can choose a Living Ceramics porcelain or optical transparent glass. The finishes of the structure are in natural varnished wood or open-pore lacquered in any the 20 colors of the collection, those showing the texture of the wood itself. Available in two sizes, 123x123x38 and 63x63x38

## LUNAA mirror

---

---

Espejos circulares, en acabados plata, gris y bronce, con los polos ligeramente achatados, en forma de cuña y con el canto lacado en los 20 colores. La base de DM se mecaniza para insertar unas pletinas, que te permiten suspenderlos con la inclinación en cuatro posiciones, derecha e izquierda y hacia arriba o hacia abajo. Ideal para decorar una entrada, pasillo, baño u local comercial, combinando medidas y colores.

Circular mirrors, in silver, gray and bronze finishes, with the poles slightly flattened, wedge-shaped and with the lacquered edge in the 20 colours of the sample book. The DM base is machined to insert some flat bars, which can be suspended in four different positions: right and left and up or down. Ideal for decorating an entrance, hallway, bathroom or commercial space, combining measurements and colours.

---

---

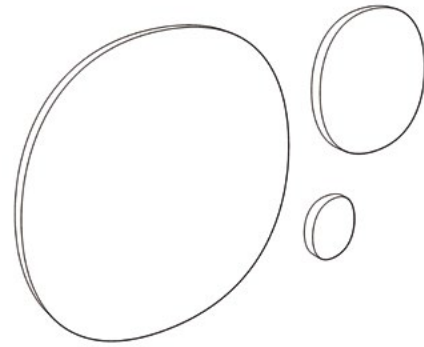

**Medidas/Sizes cm**  
(Diámetro x fondo) (Diameter x Depth)

20	x	4,5
50	x	4,5
70	x	4,5
90	x	4,5
120	x	4,5

## TRIAN mirror

---

---

Espejos decorativos, en acabados, plata gris y bronce, con forma triangular y puntas redondeadas, pegados sobre una base de DM biselada y puede lacarse en los 20 colores. Se fabrica en dos medidas, van suspendidos y se pueden orientar en cuatro posiciones.

Decorative mirrors in silver, gray and bronze finishes, triangularly shaped with rounded edges and glued on a beveled DM base that can be lacquered in the 20 colours. It is manufactured in two sizes, is suspended and can be oriented in four positions.

---

---

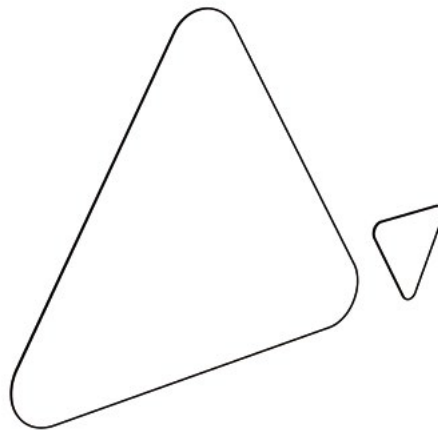

**Medidas/Sizes cm**  
(Ancho x Alto x Fondo) (Width x Height x Depth)

32,4	x	28,94	x	1,6
118,83	x	106,13	x	1,6

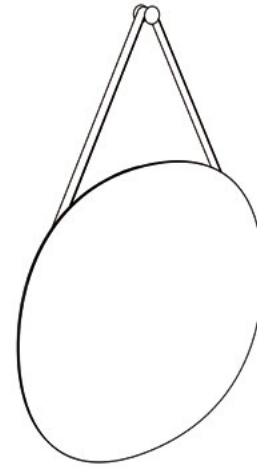

**Medidas/Sizes cm**  
(Ancho x Alto x Fondo) (Width x Height x Depth)

50	x	3,5
70	x	4,5
90	x	3,5

## LUNAA BELT mirror

---

---

Espejos circulares, en acabado plata, gris, bronce y gold, con los polos ligeramente achatados. Éstos van pegados sobre una base de DM en la que se dejan al descubierto 4mm para lacarlos en cualquiera de los 20 colores de la colección, el resto queda cubierto por una correa de cuero en negro o coñac, que va colgada a un bulón metálico lacado en uno de los 20 colores. Disponible en tres medidas 50, 70 y 90 cm.

Circular mirrors, in silver, gray, bronze and gold finish, with poles slightly flattened. These are pasted on a DM base in which 4mm are left uncovered to be lacquered in any of the 20 colours of the collection, the rest is covered by a strap of black or conyac leather, which hangs from a lacquered metal bolt. Available in three sizes: 50, 70 and 90 cm.

---

---

## VIEWS mirror.

---

---

La estética escultórica del espejo no es casual. Los planos inclinados, como pliegues de papel, rompen el reflejo mostrándonos otras realidades que cambian conforme pasamos a su lado. Los diseñadores Alberto y Patxi de Dsignio se basaron en una célebre frase de Ortega y Gasset como inspiración: “Hay tantas realidades como puntos de vista. El punto de vista crea el panorama”. Bajo este concepto surgieron los primeros bocetos que fueron tomando forma hasta materializarse en Views. Disponible en dos medidas, 150x60 y 180x60 y en espejo plata, gris, bronce y dorado. De forma opcional, luz indirecta led.

The VIEWS mirror is one of the new releases of this year. The sculptural aspect of the mirror is not accidental. Inclined planes, like folds of paper, break the reflection: showing us other realities that change as we pass by.

The designers Alberto and Patxi from Dsignio used a famous phrase by Ortega y Gasset as inspiration: “Hay tantas realidades como puntos de vista. El punto de vista crea el panorama” (“There are as many realities as there are points of view. The point of view creates the panorama”). With this concept the first sketches were taking shape until they materialized in Views.

VIEWS is available in two sizes, 150x60cm and 180x60cm; in silver, grey, bronze and gold mirror. Optionally we can add an indirect LED light.

---

---

## MARCO shelf

---

Estanterías de líneas minimalistas, en las que puedes guardar los libros más apreciados, marcos de fotos u objetos decorativos. La combinación en medidas y colores permiten personalizar cada estantería al gusto del cliente, adaptándola al diseño de su salón, oficina, entrada, baño, habitación juvenil, etc.

Desarrollado en DM lacado con las terminaciones frontales biseladas. Se fabrica en dos medidas de ancho, dos de alto y una profundidad. Dos posiciones de estantes fijos y con distancias asimétricas entre ellos. La estantería se mecaniza para que se pueda suspender en vertical y en un sentido u en otro, consiguiendo así dos posiciones diferentes de estantes. También se puede apoyar al suelo con unos topes de goma insertados en los cantos de los laterales. Esta colección te permite acabar toda la estantería en un mismo color o combinar cada pieza con el color que se desee, a elegir en cualquiera de los 20 colores del muestrario.

Shelves with minimalist lines, where you can store appreciated books, photo frames or decorative objects. The combination of sizes and colours allows the customisation of each shelf to the client's taste, adapting it to the design of his living room, office, entrance, bathroom, youth room, etc.

Developed in lacquered DM with beveled front endings.

It is manufactured in two measures of width, two of height and one of depth.

Two positions of fixed shelves and with asymmetric distances between them.

The shelving is mechanized so that it can be suspended vertically one way or another, thus achieving two different positions of shelving. You can also rest it on the floor with rubber buffers inserted in the edges of the sides. This collection allows you to finish the entire shelf in the same colour or combine each piece with the colour you prefer to choose between any of the 20 colors of the sample book.

---

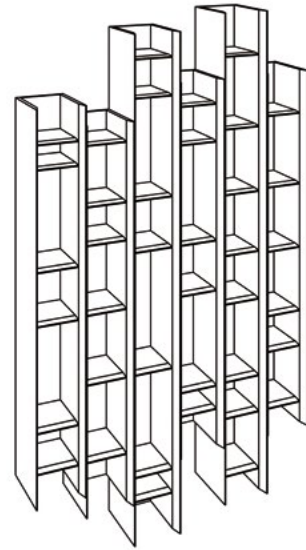

### Medidas/Sizes cm

(Ancho x Alto x Fondo) (Width x Height x Depth)  
Horizontal Shelf:

Estantería en horizontal:

220 x 44 x 40

Vertical Shelf:

Estantería en vertical:

(2 opciones diferentes de posición y número de estantes)  
(2 different options of position and number of shelves)

20 x 200 x 27

20 x 150 x 27

40 x 200 x 27

40 x 150 x 27

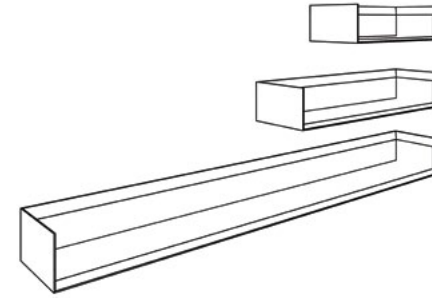

### Medidas/Sizes cm

(Ancho x Alto x Fondo) (Width x Height x Depth)

30 x 15 x 26

60 x 15 x 26

90 x 15 x 26

120 x 15 x 26

150 x 15 x 26

180 x 15 x 26

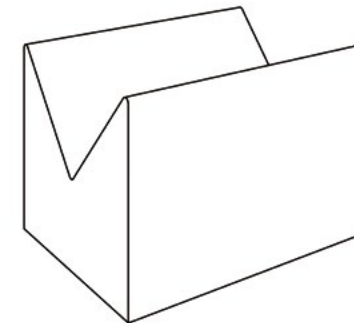

### Medidas/Sizes cm

(Ancho x Alto x Fondo) (Width x Height x Depth)

40 x 28 x 30

## SHELVES

---

Colección de estantes, realizados en DM lacado mate, que permiten soluciones individuales o crear atractivas composiciones.

Shelve está resuelta técnicamente como la colección Marco, con su misma separación de la pared, de manera que ambas se integran perfectamente.

Disponibile en una amplia gama de colores para ser integrada con naturalidad en hogar e instalaciones.

Shelves collection in matt lacquered MDF, which allow individual solutions generating creative and attractive compositions.

Shelve is technically determined as the Marco collection, with the same distance from the wall, so that both are perfectly integrated.

This collection is available in a wide range of colours to be naturally integrated into homes and commercial premises.

---

## UVE magazine rack

---

Diseñado para tener las revistas y periódicos siempre a mano y en su sitio, esta pieza es perfecta como complemento del sofá, en una sala de espera, incluso en un espacio de lectura. Se fabrica en MDF lacado en cualquiera de los 20 colores de la colección y en un único tamaño 30x40x28 cm.

Designed to have magazines and newspapers always at hand and in their place, this piece is perfect as a complement to the sofa, in a waiting room, even in a reading space. It is manufactured in lacquered MDF in any of the 20 colors of the collection and in a single size 30x40x28 cm.

---

## ADE flower pot

---

Colección de cubre maceteros formados por cuatro elementos realizados en DM lacado mate que se unen gracias a un marco interno oculto.

Su elegante encuentro entre paneles, dejando un sutil espacio entre ellos, y sus múltiples colores disponibles hacen de ADE una colección ideal para integrar la vegetación en nuestros interiores.

ADE is our collection which covers plant pots made by four elements of matt lacquered MDF joined together thanks to a hidden inner frame.

Its smart contact between panels leaves a subtle space between them, and their multiple available colors makes ADE an ideal collection which integrates a natural look alongside your interior.

---

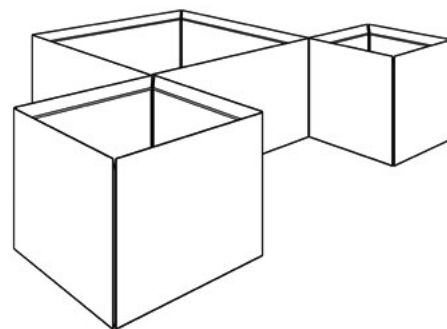

**Medidas/Sizes cm**  
(Ancho x Alto x Fondo) (Width x Height x Depth)

40 x 40 x 40  
50 x 40 x 50  
80 x 40 x 40  
120 x 40 x 40

## OCTO low table

---

Mesas auxiliares con forma octogonal, con las aristas redondeadas dando suavidad y belleza a la pieza. Pensadas como mesas de centro, de noche, peana... Se fabrica en DM, en una medida de base de 36x36 y dos de altura 40 y 45. Terminado en laca microtexturizada, en brillo liso y cualquiera de los 20 colores de la colección ALBIOL.

Auxiliary tables with octagonal shape and rounded edges that provide softness and beauty to the piece. Designed as a coffee table, side table, stand ... It is manufactured in DM, in a base measure of 36x36 and two different heights, 40 and 45. Finished in micro-textured lacquer, smooth gloss and any of the 20 colours of the ALBIOL collection.

---

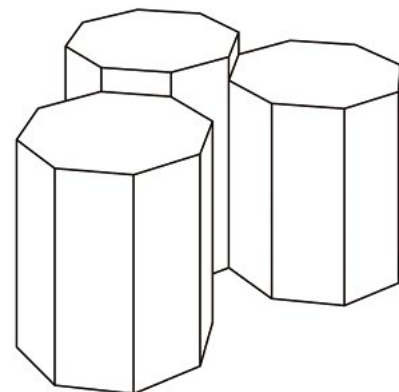

**Medidas/Sizes cm**  
(Ancho x Alto x Fondo) (Width x Height x Depth)

36 x 40 x 36  
36 x 45 x 36

## JUD table

---

Colección de mesas con tapa en DM lacado mate en los 20 colores de la colección o DM rechapado de roble. Patas de acero calibrado lacado en los acabados ALBIOL.

Su ingenioso sistema constructivo basado en una pata técnicamente resuelta para no precisar de estructura le permite ser atornillada directamente a la tapa consiguiendo gran estabilidad.

JUD dispone de múltiples medidas, acabados y combinaciones para abrazar soluciones tanto en hogar como en restaurantes, oficinas, etc.

Jud is our collection of tabletops which are in matt lacquered MDF and it can be found in one of the 20 colours of our collection or veneered in oak MDF. ALBIOL also finishes lacquered calibrated steel legs.

Its ingenious construction system is based on a technically determined leg which does not require a structure and allows it to be directly bolted to the tabletop achieving maximum stability.

JUD has multiple sizes, finishes and combinations to embrace solutions at home, in restaurants and premises, etc.

---

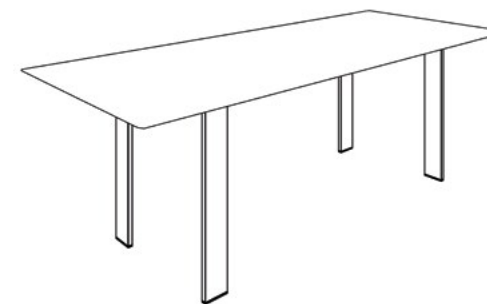

**Medidas/Sizes cm**  
(Ancho x Alto x Fondo) (Width x Height x Depth)

100 x 74,5 x 100  
140 x 74,5 x 140  
180 x 74,5 x 90  
220 x 74,5 x 90

(Diámetro x Alto) (Diameter x Depth)

100 x 74,5  
120 x 74,5  
160 x 74,5

## JUD bed base

---

Cama de tablero fenólico de abedul, con una superficie rugosa y muy resistente, sujeta a una estructura metálica con las patas de 10x2, orientadas estratégicamente para que sea más estable y mantengan el diseño de las mesas Jud. La estructura es más pequeña que el tablero, consiguiendo que dé una sensación de gran ligereza. Disponible para colchón de 90, 150, 180 y 200 de ancho por 200 de largo.

Phenolic birch board bed, with a rough and very resistant surface, held by a metal structure with 10x2 legs, strategically oriented to be more stable and maintain the design of the Jud tables. The structure is smaller than the board, providing a feeling of great lightness. Available for 90, 150, 180 and 200 wide by 200 long mattresses.

---

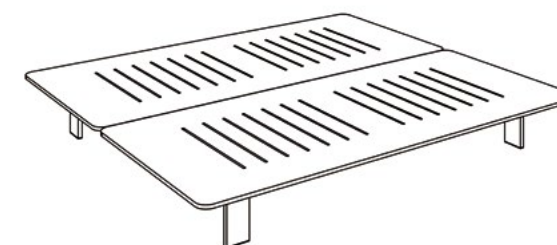

**Medidas/Sizes cm**  
(Ancho x Alto x Fondo) (Width x Height x Depth)

90 x 26,5 x 200  
150 x 26,5 x 200  
180 x 26,5 x 200  
200 x 26,5 x 200

## MARCO

---

Colección basada en un marco perimetral de DM lacado mate o roble macizo, que recoge en su interior múltiples opciones. Las veinticinco medidas de la colección permiten innumerables combinaciones. En su interior se pueden adaptar paneles con espejos plata, gris o bronce; lacados con los veinte colores de la colección; madera de roble o tapizados liso, a bandas y capitoné. El detalle técnico al separar el marco de la pared le otorga gran ligereza y un aspecto realmente elegante. Los herrajes para suspenderlos permiten que los puedas posicionar tanto en vertical como en horizontal. Marco ofrece las siguientes posibilidades:

- Marcos con espejos, paneles lacados mate o de roble.
- Marcos con paneles acústicos con diversos tapizados.
- Marcos para cabeceros con paneles lacados mate, de roble o tapizados.
- Marco 360°, una original propuesta con espejo plata, vertical y giratorio, perfecto para hogar e instalaciones comerciales. Su trasera es lisa y cuenta con una útil y discreta percha cilíndrica.

Our collection MARCO is based on a MDF perimeter frame with a matt or solid oak finish which gathers up several options. The twenty five measures of the collection allow countless combinations. Inside we can customize panels with silver, grey or bronze mirrors, lacquered with one of the twenty colours from the collection. It can also be made of oak wood, plain, striped or quilted upholsteries. As you separate the frame from the wall, the technical details make it look light and fashionable. The ironwork used to hang them allows you to place them either vertically or horizontally. Marco offers the following possibilities:

- Frames with mirrors, lacquered, matt or oak panels.
- Frames with acoustic panels and several upholsteries.
- Frames for headboards with lacquered, matt, oak or upholstered panels.
- 360° Marco, an original proposal with silver, vertical and turntable mirror, perfect for your house and commercial premises. Its rear is plain and has a discreet and useful cylindrical hanger.

---

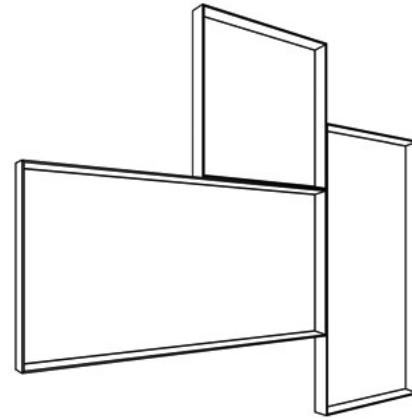

**Medidas/Sizes cm**  
(Ancho x Alto x Fondo) (Width x Height x Depth)

30 x 30 x 6  
30 x 60 x 6  
30 x 90 x 6  
30 x 120 x 6  
30 x 150 x 6  
30 x 180 x 6  
30 x 210 x 6

60 x 60 x 6  
60 x 90 x 6  
60 x 120 x 6  
60 x 150 x 6  
60 x 180 x 6  
60 x 210 x 6

90 x 90 x 6  
90 x 120 x 6  
90 x 150 x 6  
90 x 180 x 6  
90 x 210 x 6

120 x 120 x 6  
120 x 150 x 6  
120 x 180 x 6  
120 x 210 x 6

150 x 150 x 6  
150 x 180 x 6  
150 x 210 x 6

MARCO 360°

42 x 180 x 22

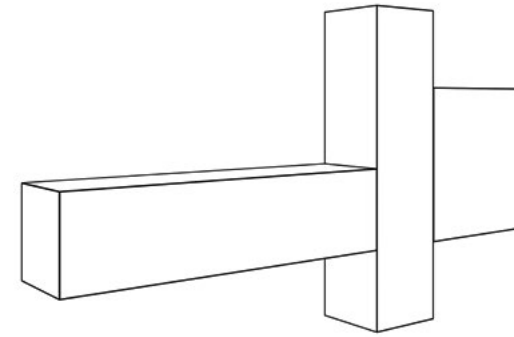

**Medidas/Sizes cm**  
(Ancho x Alto x Fondo) (Width x Height x Depth)

30 x 60 x 30 1 estante/1 stack  
60 x 60 x 30 1 estante/1 stack  
30 x 120 x 30 2 estantes/2 stacks  
30 x 180 x 30 4 estante/4 stacks

30 x 60 x 40 1 estante/1 stack  
60 x 60 x 40 1 estante/1 stack  
30 x 120 x 40 2 estantes/2 stacks  
30 x 180 x 40 4 estante/4 stacks

60 x 30 x 30 vacío/empty  
120 x 30 x 30 1 estante/1 stack  
180 x 30 x 30 1 estante/1 stack

60 x 30 x 40 vacío/empty  
120 x 30 x 40 1 estante/1 stack  
180 x 30 x 40 1 estante/1 stack

## SILBOX

---

Sistema de contenedores con puertas batientes o abatibles, realizado íntegramente en DM con los colores de la colección Albiol en mate y brillo. Sus exquisitos encuentros a 45° hacen de SILBOX una propuesta de gran elegancia y totalmente atemporal para los clientes más exigentes. Calidad y diversidad de uso son los parámetros principales de la colección SILBOX.

It is a container system with hinged or folding doors entirely made of MDF in Albiol's matt and gloss colours. Their well-crafted 45° joints make SILBOX a proposal of great elegance and totally timeless for the most demanding customers. Quality and diversity of use are the main parameters of the SILBOX collection.

---

## AITANA table

---

Mesas auxiliares de exquisitas proporciones y múltiples colores. Realizada íntegramente en DM lacado mate. La forma especial de su tapa junto con sus pies integrados, hacen de Aitana una exclusiva colección, de gran utilidad como mesas de centro, de noche, auxiliar, infantil, etc. Disponible en tres dimensiones. Su sencillez en sus formas y terminaciones redondeadas le dan a la colección un diseño fresco, ligero y novedoso.

AITANA is our collection of tables consisting of excellent proportions and multiple colours.

It is made entirely in matt lacquered MDF.

The special shape of the tabletop together with its integrated feet makes Aitana an exclusive collection of practical and stylish coffee tables, nightstands, side tables and tables for children.

It is available in three dimensions. Its simplicity is its form and rounded ends which give the collection a fresh, light and innovative design.

---

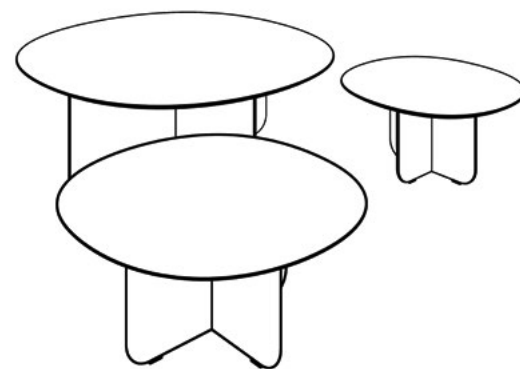

**Medidas/Sizes cm**  
(Diámetro x Alto) (Diameter x Height)

50 x 29  
70 x 32  
90 x 35

## ZARA table

---

Mesas auxiliares basadas en los clásicos pero reduciendo sus formas hasta la esencia. Realizada la tapa y la base en DM y la columna de unión entre ambas en metal. Toda la mesa lacada con los 20 colores de la colección Albiol. Perfectas como mesas de centro en zonas de espera. Disponible en tres dimensiones.

Our ZARA collections are side tables based on the classics but reducing their forms to the essence. The tabletop and the legs are made of MDF and the joining column is made of metal. It is lacquered with one of the 20 colours of the Albiol collection.

Our ZARA collection is ideal to be used as coffee tables in waiting areas.

It is available in three dimensions.

---



**Medidas/Sizes cm**  
(Diámetro x Alto) (Diameter x Height)

60 x 43  
70 x 30  
44 x 57

## Albiol custom

La colección ALBIOL es habitualmente customizada por nuestros mejores clientes, tanto en medidas especiales como en acabados.

Realizar una medida especial siempre conlleva un tratamiento diferente a nuestro proceso productivo de serie, tanto en plazos de entrega como en pedidos mínimos o respuesta ante incidencias al no disponer de stock, pero si cuentas con ello nosotros haremos lo posible por llevar a cabo tu proyecto.

Por favor consulta con nosotros tus necesidades para que estudiemos la mejor solución para tu proyecto.

ALBIOL collection is usually customized for our best customers, both in special measures and finishes.

Ordering special measures entails a different process to our production of the series.

Therefore, delivery time will vary and a minimum order quantity will apply.

Please consult us whatever your needs are, so we can study the best solution for your project.

Colores  
Colors

White	Light grey	Yellow
Sand	Blue sky	Mustard
Smoke	Northblue	Orange
Bronze	Blue ocean	Red
Tobacco	Pistachio green	Rubine red
Graphite	Moss green	Pink
Black	Olive green	

ALBIOL 202

Espejos  
Mirrors



silver

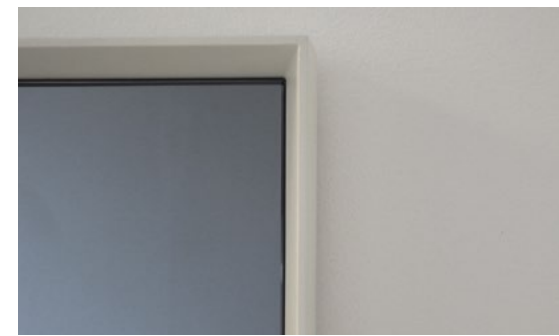

grey

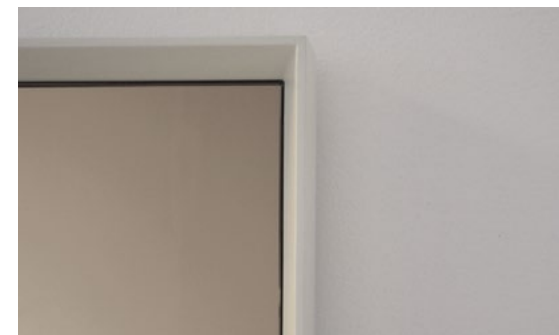

bronze

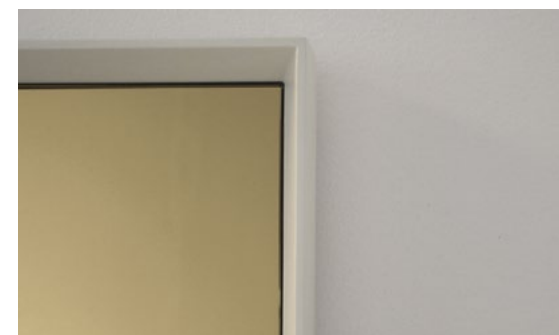

gold

Maderas  
Woods



matt natural oak

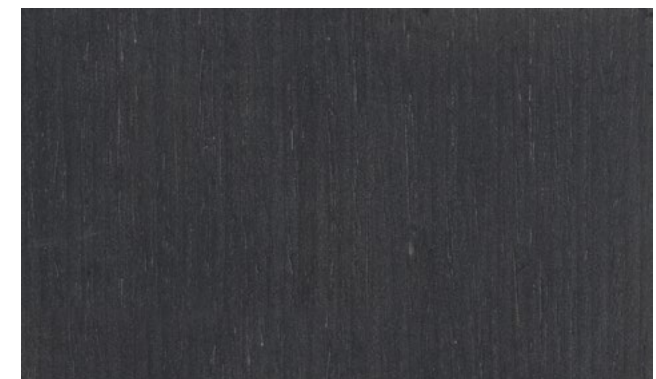

matt ash oak

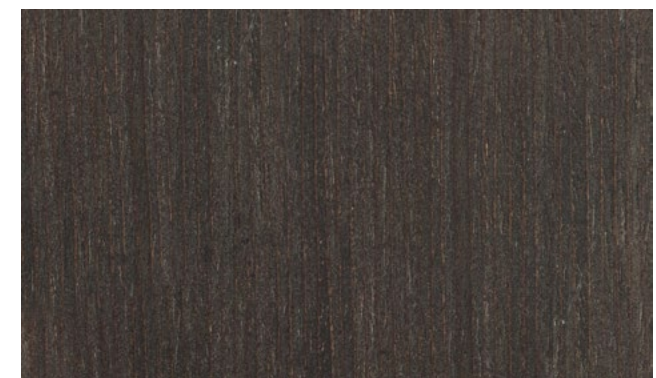

matt wenge oak

Dirección creativa. Creative Direction:  
ESTUDIO\_V

Diseño y maquetación.  
Design and page layout  
[sorayapla.com](http://sorayapla.com)



**Albiol modular, S.L.**  
**Avd. Casalduch, 53 (bajo)**  
**12005 Castellón - Spain**  
**34 964 050 236**  
**[info@albiolmodular.com](mailto:info@albiolmodular.com)**  
**[www.albiolmodular.com](http://www.albiolmodular.com)**

